





JULIAN CHICHESTER

PALAZZO MIRROR ASSEMBLY INSTRUCTIONS

NO.	ITEM	DESCRIPTION	QTY
A		Aluminium Hanger	1
B		Steel Screw M5*40mm	6
C		Wall Plug	6
D		Screwdriver	Not Included

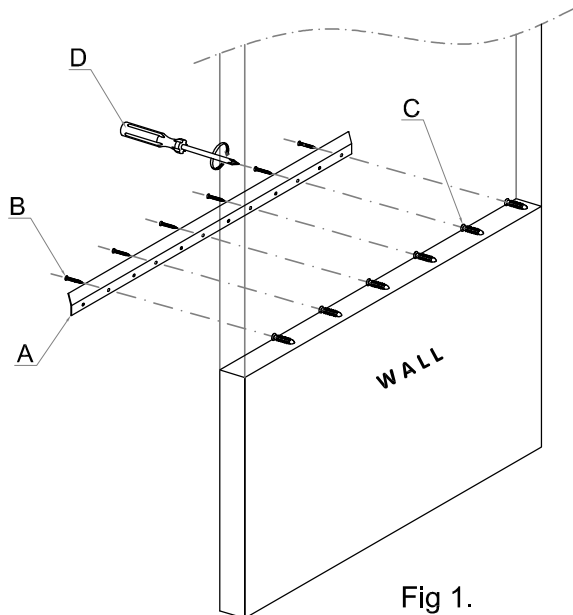
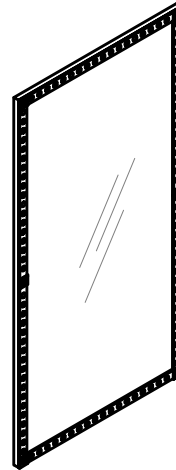
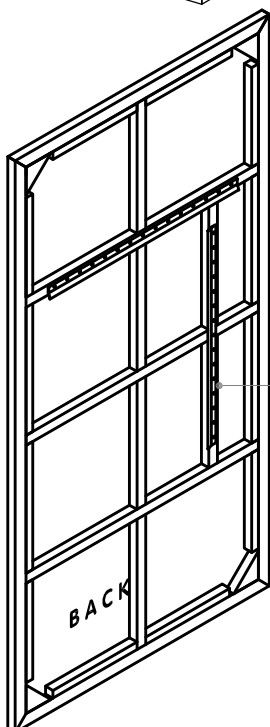

Fig 1.



Mirror can be hung in portrait or landscape position.

IMPORTANT SAFETY INSTRUCTIONS

Professional installation is strongly recommended.

For your safety, it is recommended that two people hang the fixture.

These instructions are provided for your safety. It is important that they are read carefully and completely before installation of the fixture.

Check with a professional to ensure your wall can tolerate a fixture weighing **77 lb / 35 kg**.

It is imperative that the mirror is mounted into a wall stud

TO ASSEMBLE

1. Unpack all parts and place them on a protected work surface.
2. Determine the exact location of the fixture and mark the holes on the wall surface using the holes in the aluminum hanger (A) as a guide. Fig 2 shows the distance between the two hangers.
3. Drill small holes on each point location on the wall. Each hole should be just large enough to accommodate plastic wall plug (C).
4. Insert the plastic wall plug (C) into the holes on the wall.
5. Mount the aluminum hanger into the wall using screw (B).
6. Check that the aluminum hanger fixture is securely screwed into the wall.
7. Place the mirror with hanger cleat into the aluminum hanger fixture.
8. Installation is complete.

CARE INSTRUCTIONS

To clean, use a damp cloth or mild detergent if necessary, do not use abrasive cleanser.

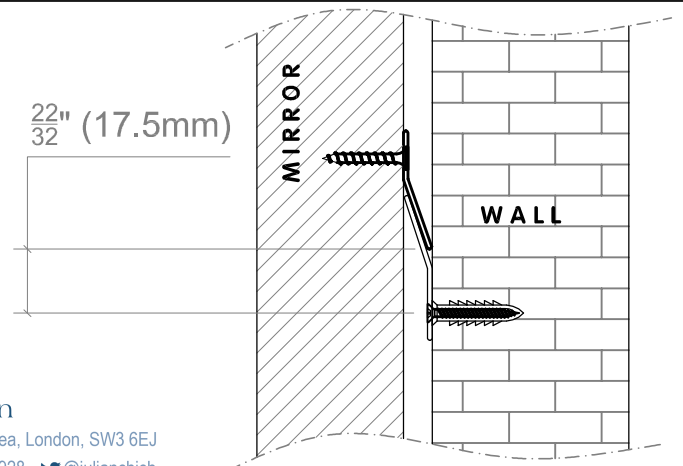

Fig 2.

London

1-4 Queen's Elm Parade, Chelsea, London, SW3 6EJ

Showroom +44(0) 20 7622 2928 @julianchich

sales@julianchichester.com

julianchichester.com